

MAX. 0.76in
MIN. 0.68in
[19.4mm]
[17.4mm]
ADJUSTABLE
CCD IMAGE PLANE

1.000\"/>

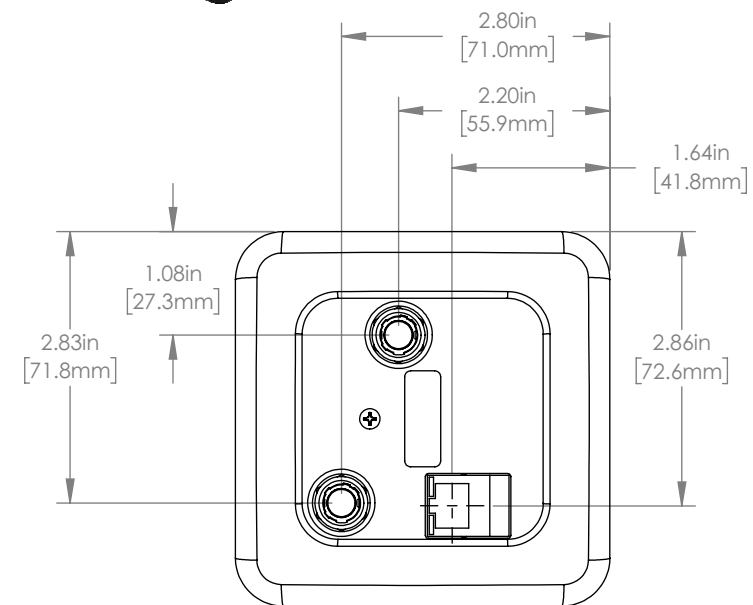
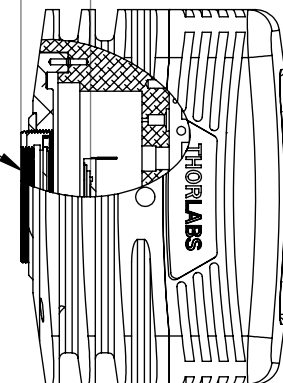

REFER TO USERS MANUAL
FOR INTERCONNECT DETAILS

DRAWING PROJECTION

	NAME	DATE
DRAWN	J.O.	7/8/16
APPROVAL	M.P.	7/8/16

COPYRIGHT © 2016 BY THORLABS

VALUES IN PARENTHESIS ARE CALCULATED AND MAY CONTAIN ROUND OFF ERRORS

THORLABS
www.thorlabs.com

DIGITAL SCIENTIFIC CAMERA

MATERIAL	N/A	REV A
----------	-----	----------

ITEM #	APPROX WEIGHT
1501M-GE-TE	1.0 kg

FOR INFORMATION ONLY
NOT FOR MANUFACTURING PURPOSES

ROHS COMPLIANT